

PRODUCT SPECIFICATIONS

Elkay Dependabilt Stainless Steel 21" x 25-13/16" x 43-3/4" 18 Gauge One Compartment Sink with Stainless Steel Legs. Sink is manufactured from 18 gauge 300 series Stainless Steel with a #4 Finish, Center drain placement.

Material:	300 series Stainless Steel
Finish:	#4 Finish
Gauge:	18
Weight Without Packaging:	70
Number of Bowls:	1
Sink Dimensions:	21" x 25-13/16" x 43-3/4"
Bowl 1 Dimensions:	16" x 20" x 12"
Drainboard Location:	No drainboard
Backsplash Height:	9
Leg Type:	Stainless Steel
Drain Size:	3-1/2" (89mm)
Drain Location:	Center

Special Note: Requires single splash mount faucet (not included).

Custom Options	
Alternate Punching	
<input type="checkbox"/> Faucet Model:	<input type="checkbox"/> Punch Required:

*Options available if applicable



Included with Product: Stainless steel legs and adjustable bullet feet.

AMERICAN PRIDE. A LIFETIME TRADITION.
Like your family, the Elkay family has values and traditions that endure. For almost a century, Elkay has been a family-owned and operated company, providing thousands of jobs that support our families and communities.

Product Compliance: ASME A112.19.3/CSA B45.4
NSF 2

Accessory: ASME A112.18.2/CSA B125.2

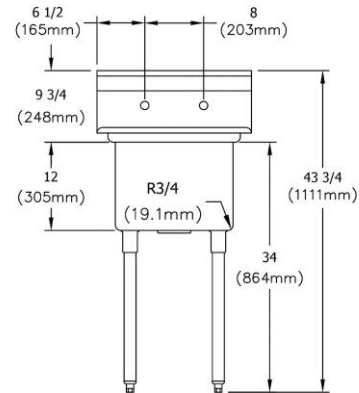
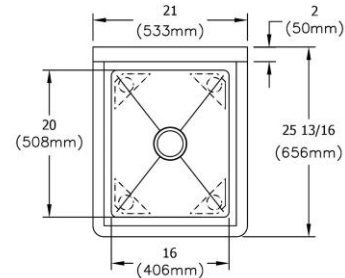

PART: _____ QTY: _____

PROJECT: _____

CONTACT: _____

DATE: _____

NOTES: _____

APPROVAL: _____

In keeping with our policy of continuing product improvement, Elkay reserves the right to change product specifications without notice. Please visit elkay.com for the most current version of Elkay product specification sheets. This specification describes an Elkay product with design, quality, and functional benefits to the user. When making a comparison of other producers' offerings, be certain these features are not overlooked.