



Nina

The Nina is a classic, free-standing bathtub, updated with all the modern amenities. Not only a feast for the eye but the body as well.

Available Sizes:

72"L x 44"W x 22"D
90 Gallons



Acrylic Tub – construction features

Acrylic models finished in 1/8" thick layer of deep lustrous acrylic.
Extra thick reinforced fiberglass.
Pre-wired pump on pump platform (standard pump location only)
Integral E-Z Level platform facilitates installation.
Non-skid bottom.

PVC Systems – include:

8 Fully directional adjustable PVC jets
Anti-vortex safety suction.
Color matched system trim
Hydrozone ozone sanitation system
Rigid PVC piping
Self draining pump and system
Soft Touch electronic on/off control with 30-min. integral timer
2.25 HP Single Speed Pump
Cable waste & overflow

Hydro Systems – Options:

Available as Tub only, Thermal Air, Whirlpool or Combo
Microban Antibacterial Protection
Extra High Density Fiberglass
No Skirt (optional)
Custom jet and pump locations
Plated Metallic finish
Additional directional Jets
Swirling, Rotating, or Jumbo Jets
Micro Therapy Jet
Integral Waste & Overflow
1.5 HP Variable Speed Pump (digital temperature display optional)
Electronic low water protection
In-line Heater
Chromatherapy-LED Lighting System
Chromatherapy-LED Mini Spotlights
Mood Light
Grab Bars

Neck Masseur Pillow
Hydro Fusion
Hydro Coat
Hydro Express quick ship

Approvals & Listings

Commonwealth of Massachusetts
UPC & USPC - US & Canada









Nina

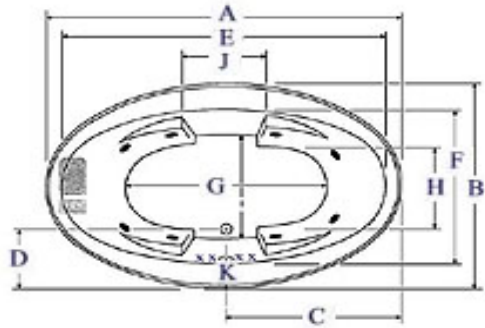

Must be set in Mortar Base



Edge Detail

-  Pump motor
-  Jets
-  Anti-vortex suction
-  Overflow location

AS SHOWN:
Whirlpool option w/ standard jets

ALSO AVAILABLE:
Soaking Tub Only, Whirlpool,
Thermal Air, Combo

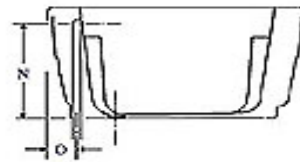
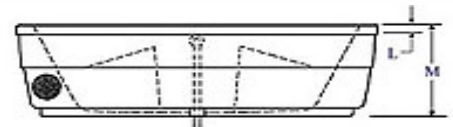

Model	GC	AC	A	B	C	D	E	F	G	H	I	J	K	L	M	N	O
7244	N/A		72"	44"	36"	12 ³ / ₄ "	64 ¹ / ₂ "	32 ¹ / ₂ "	46"	24"	28"	17"	4 ³ / ₄ "	2 ¹ / ₂ "	22"	19"	5 ¹ / ₂ "
Amp		Volt		Breaker			Dedicated Service					Jet		Pump		Wat.Cap.	
13.5		120		20 amps			GFCI Protected					8		2.25		90 gal.	

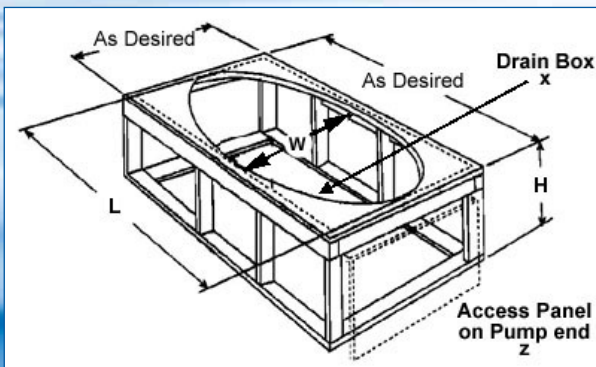

Island Drop-In			
Model	(L)ength	(W)idth	(H)eight Finish
7244	70"	42"	20 ³ / ₄ "

Disclaimer: Certain options or altering the pump/blower location may cause the pump/blower to extend beyond the tub decking. For cutout dimensions wait for unit to arrive. All specifications subject to change without notice.