

MUNICH COLLECTION
DOUBLE SHOWER
DOOR HANDLE 8"
2887808

PRODUCT NAME: DOUBLE SHOWER
DOOR HANDLE 8"

PRODUCT CODE: 2887808

MATERIAL: All-brass construction

KEY FEATURES: Contemporary design.
Strong rectangular shapes,
balanced by slender linear lines.

STOCKED FINISHES:

- Polished Chrome (99)
- Brushed Nickel (81)
- Polished Nickel (68)
- Matte Black (48)

SPECIAL FINISHES AVAILABLE: 26 options available.
Please see our website for
full list samples

WARRANTY:

Lifetime Limited (Residential Use)
One Year (Commercial Use)

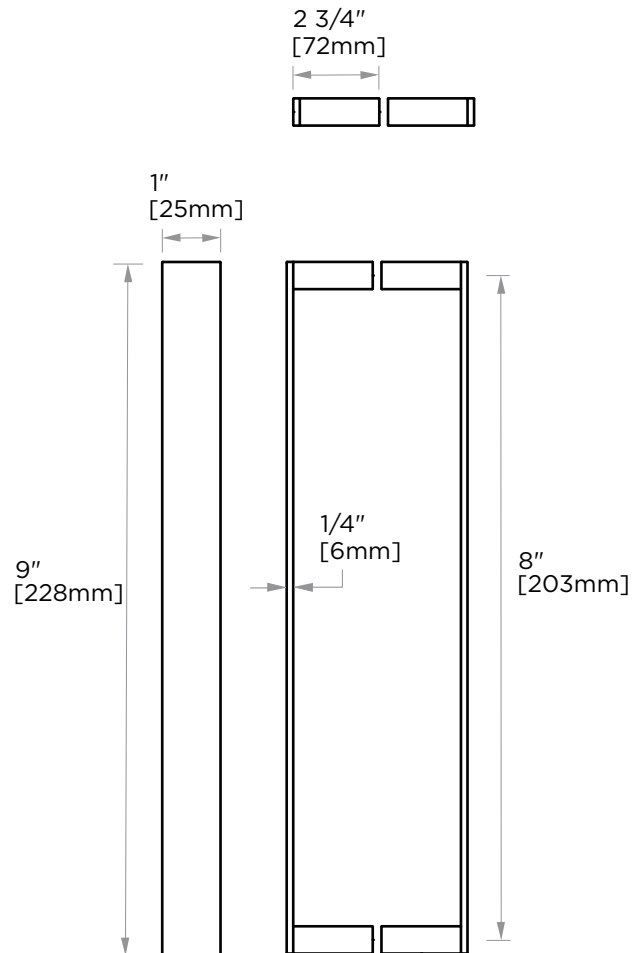

NOTE: Dimensions and specifications are subject to change without notice.

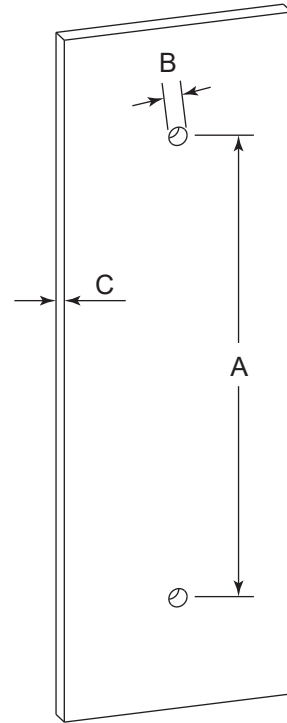
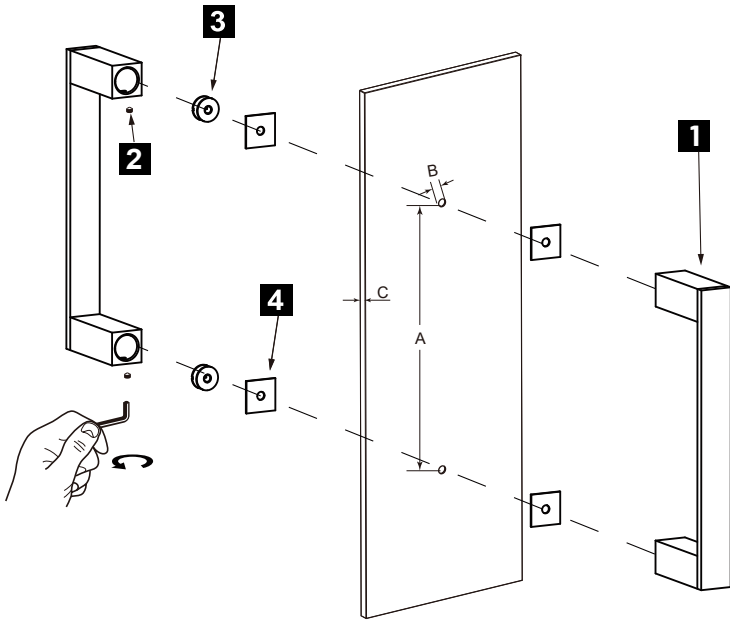

HANDLES INFO

Components Included		
①	Handle	X1
②	Set Screw M6	X2
③	Fixing Bracket	X2
④	Rubber Gasket	X4

GLASS INFO

Glass Hole C-C Distance		
A	8"/203mm	8" Shower Door Handle
	12"/305mm	12" Shower Door Handle
	18"/457mm	18" Shower Door Handle
	24"/610mm	24" Shower Door Handle
	36"/914mm	36" Shower Door Handle
B	1/2" (12mm)	Glass Hole Diameter
C	6-12mm	Glass Thickness

Mounting Kits Included		
	X1	Allen Key

* Can be used with extension kit for thicker doors

NOTE: Dimensions and specifications are subject to change without notice.