



Shown in AG04A-BRS



AG04A

Artisan Glass Small Rectangle Solid Églomisé

DETAILS

Installation Type: Undermount or Drop-in (Add \$200)

Material: Glass

Standard 1.5" Drain, No Overflow

Dimensions are approximate: [OD: 18"x12"x4", ID: 15.5"x10"]

Each Sink is hand-crafted; no two sinks will be the same.

All handmade glass sinks are expected to have inherent and unique markings such as air bubbles, leaf marks, surface pinholes and maker's marks.



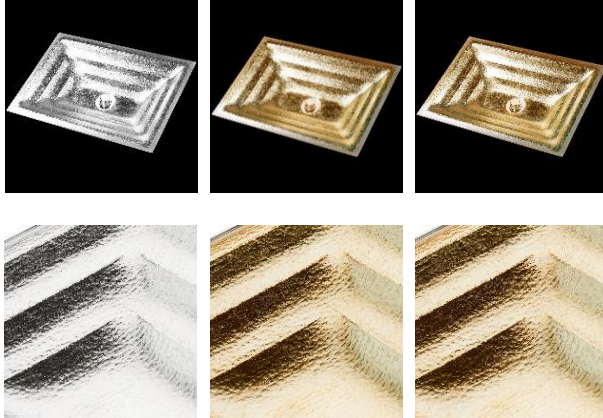

See our "Artisan Glass Fact Sheet" for additional details.

SINK FINISHES

	BRS	Brass
	GLD	Gold
	SLV	Silver



AVAILABLE DRAINS

	D004	Grid Strainer
	D005	Lift and Turn
	D006	Pop-Up with Horizontal Lift Rod
	D011 – D017	Decorative Grid Strainer

DO NOT use compression (i.e. click-clack, press-to-close/open) type drains. Hand tighten drain.

INSTALLATION

Use silicone adhesive to adhere sink to countertop. Clean any excess silicone from sink surface. Do not install sink using clips. **Hand-tighten drain – do not overtighten.** Conversion Kit for drain installation is included with each sink.

CARE

Mild soap and water for everyday cleaning. Non-ammonia-based glass cleaner may also be used. No harsh or acidic cleaning products.

WARRANTY

Linkasink warranties our product to be free from manufacturing defect for the life of the product. Warranty does not cover improper care, neglect or abuse or normal wear-and-tear.

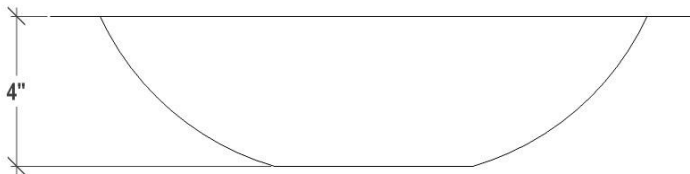
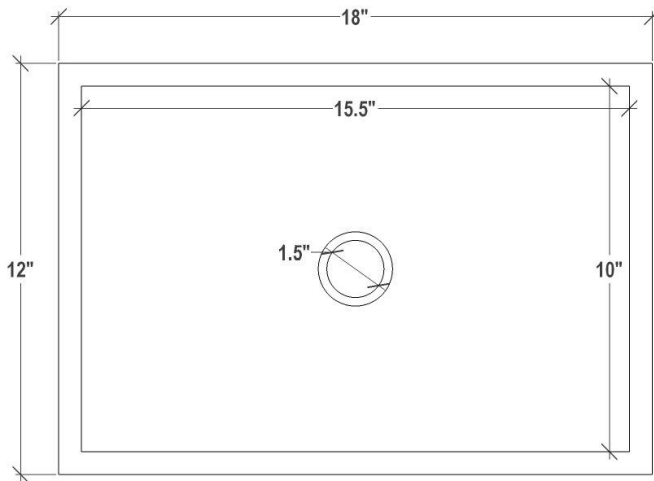

DIMENSIONS WILL VARY

DO NOT use this sheet as a guide for countertop cuts. Due to the handmade nature of each product, templates are not provided.

P: 602.971.2502
E: sales@linkasink.com

Linkasink may make changes to specifications without notice.
Visit linkasink.com for updated specification sheet.

3/03/2023