

133-4.4-JA4

Wall Mounted Bidet Spray Set with Progressive Mixer

For use with SS-SHV1.2 Concealed Rough

Note: Some building codes may require backflow preventors installed in the supply lines

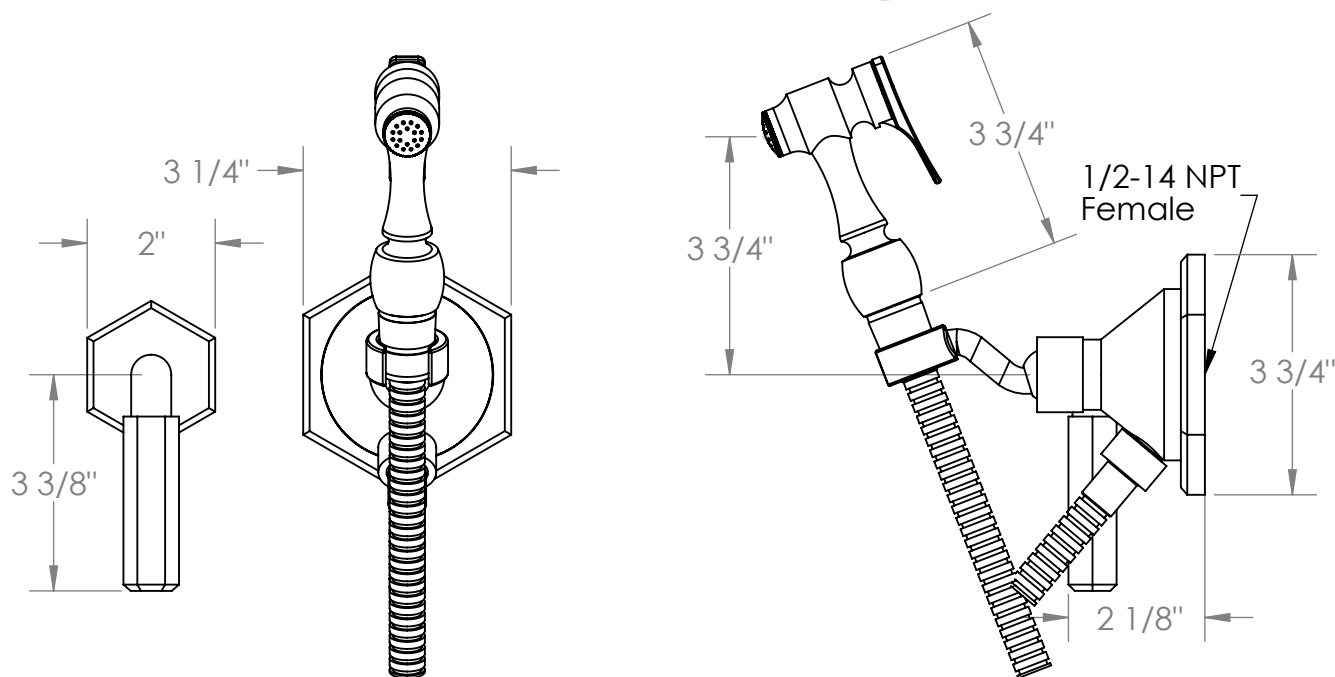
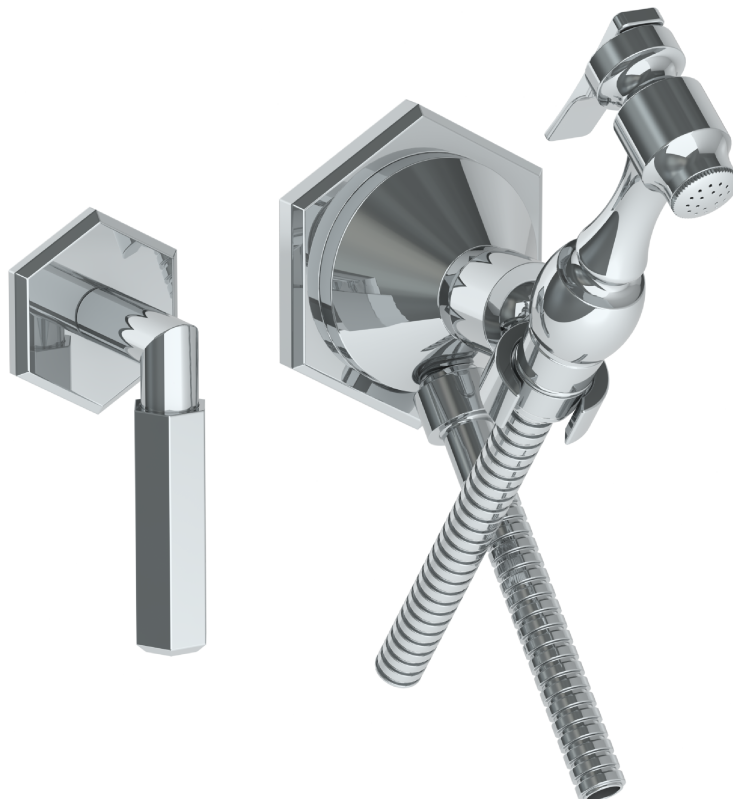

Meets the applicable requirements of ASME A112.18.1-2005/CSA B125.1-05, entitled "Plumbing Supply Fittings"